

## 3" Watermelon Double Face High Power LED Pedestal Light

Turn Signal/Marker & Clearance

Grand General is excited to expand our popular line of watermelon lights with the launch of a powerful new 3" double face pedestal light. This all-in-one unit offers exceptional performance, combining high functionality and design. The kit comes in three variations and features a fully sealed, water resistant lens equipped with 18 high powered LEDs per side for outstanding brightness.

Combined with our brackets, these lights can be easily mounted on mirrors, bumpers, fenders, and more, and support both marker and turn signal functions.

- LED..... 18 High power LEDs per side - 12V
- Size..... 3" Dia x 4-5/8" D x 3-9/16" H, stud size: 1-5/8" L
- Material..... Chrome die cast housing, polycarbonate lens sonically sealed
- Installation..... 3 Wires, hardwired  
Mounting hardware included
- Unit & Package ..... Sold by each, carded for display



Part No.	Side A	Side B
75197	Amber/Amber	Red/Red
75198	Amber/Clear	Red/Clear
75199	Amber/Smoke	Red/Smoke



75198  
Front view

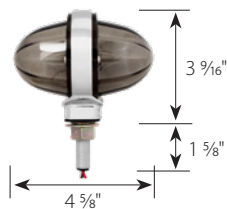

75199  
Side view



75198  
Side A

**NEW**

HIGH POWER  
**WATERMELON**  
LEDS



75197

### Variations and Related Products



## 3.5" Watermelon Lens Stainless Steel Bulb Holder with Twist-On Bulb Socket

**EASY ON/OFF**  
BULB SOCKET

At Grand General, we're committed to improving great products. We are now featuring a top-of-the-line stainless steel base that includes a high quality, water resistant, twist-on/twist-off bulb holder compatible with 1156 and 1157 style bulbs, with a built in rubber gasket to help eliminate moisture buildup.

The stainless steel is highly polished to enhance light output and includes a dedicated ground wire for easy installation.

The perfect fit for 3.5" watermelon glass lenses.

- Bulb Base** ..... 1156 Single or 1157 double - 12V
- Size**.....3-5/16" Dia x 1 1/16" H
- Features**..... Quick and easy twist-on/twist-off bulb socket  
Specially designed water resistant heavy duty wire grommet helps keep moisture out  
Mirror polished 430 grade stainless steel bulb holder plate for brighter light output
- Installation**..... 1156 Base: 2 wires, hardwired  
1157 Base: 3 Wires, hardwired  
Recommended: 1-1/2" Hole for bulb socket
- Unit & Package** ..... Sold by each, bulk



**WATER RESISTANT**  
HEAVY DUTY WIRE GROMMET

Part No.	Description
79766	1156 Bulb Base
79767	1157 Bulb Base

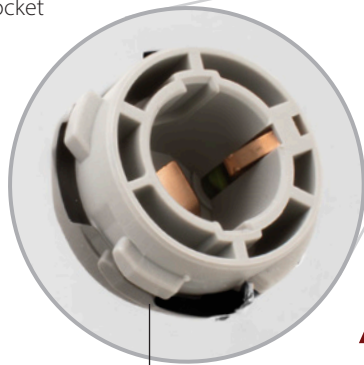

Quick twist-on/twist-off bulb socket

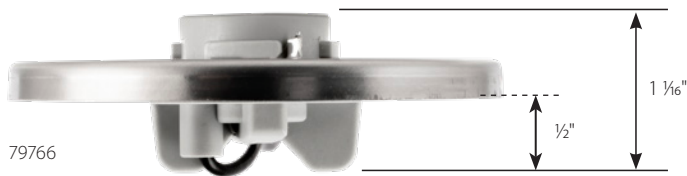

Side view

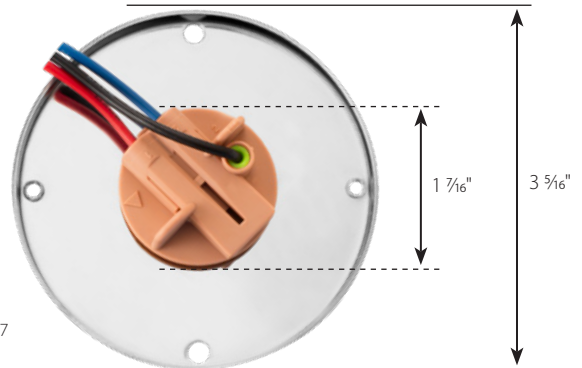

Back view

**NEW PRODUCTS | OCTOBER 2024**

**Swan Hood Ornament  
With Vintage Style Wings**

In response to popular demand, we are introducing a new style of swan hood ornaments. Our latest addition features vintage 1940s smooth style wings.

The ornament is made from a one piece, high quality metal composite and is topped with a show quality chrome finish. Available in two different variations.

Be sure to complement these collector pieces with our LED bases for enhanced accent lighting.

- Material**..... Heavy duty metal composite casting  
Superior chrome plated finish
- Size**..... Deluxe: 5-1/8" L x 4-1/8" W x 7-5/16" H  
Original: 5-1/2" L x 4-1/8" W x 7-1/2" H
- Features**..... Vintage style wings from the 1940s
- Installation**..... 2-1/2" Bolt pattern, 2 mounting holes  
Mounting gasket & hardware included
- Unit & Package**..... Sold by each, color display box

CLASSIC  
**VINTAGE STYLE  
WINGS**

**NEW**

*Classic*



**HEAVY DUTY**  
COMMERCIAL GRADE

YouTube



Scan Me

Part No.	Description
48003	Chrome Deluxe
48005	Chrome Original Style

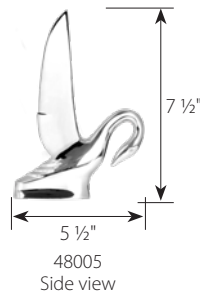
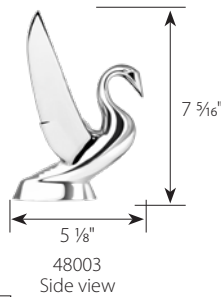

48005

**Variations and Related Products**



NEW PRODUCTS | OCTOBER 2024

**Classic Watermelon LED Cab Light with Chrome Plastic Housing**

HIGH POWER  
**WATERMELON LEDS**  
FULLY ASSEMBLED

**NEW**

Marker & Clearance

Our economy cab marker lights deliver exceptional quality without compromise. We now offer a fully assembled kit featuring our classic polycarbonate LED watermelon lens housed in a premium chrome plastic housing.

Available in three variations, the kit includes a fully sealed, water resistant lens with 18 high powered LEDs that provide outstanding glow and brightness.



On  
93520



Off  
93525

- LED..... 18 High power SMD LEDs - 12V
- Size..... 3-1/2" Dia x 14-1/2" L
- Material..... Chrome plastic housing with sealed polycarbonate lens and housing
- Installation..... 8" Lead hardwired with two 0.180 bullet plug  
Black foam mounting gasket included
- Unit & Package ..... Sold by each, carded for display



**DOT**  
PENDING

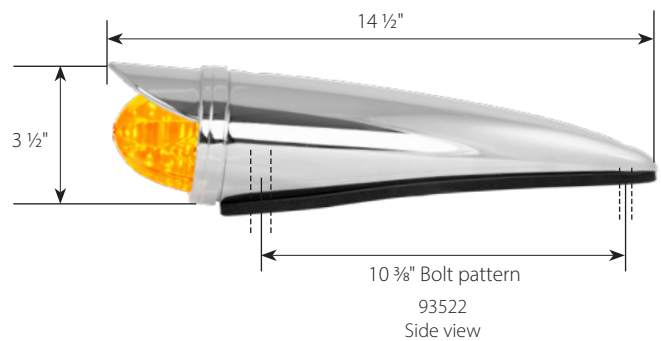

w/ S.S. Bezel	w/ Chrome Bezel w/ Visor	LED/Lens Color
93520	93522	Amber/Amber
93521	93523	Amber/Clear
93524	93525	Amber/Smoke

Variations and Related Products

